



Galpão do Vidraceiro®

ALUMÍNIO

*** EM BARRAS À PRONTA ENTREGA***

ANODIZADO E PINTADO

ENVIDRAÇAMENTO DE SACADA

SISTEMA EURO GLASS

PRONTA ENTREGA

KIT BOX E KIT JANELA

FABRICAÇÃO PRÓPRIA

PREÇOS ESPECIAIS PARA REVENDA

Tel: 11 2614 7350
11 2296 9000

ID: 55*9*48189

www.galpaodovidraceiro.com.br

Rua Candido Vale, 332 Tatuapé-São Paulo - SP



www.galpaodovidraceiro.com.br

Tel: 11 2296 9000

NEXTEL: ID 55*9*48189

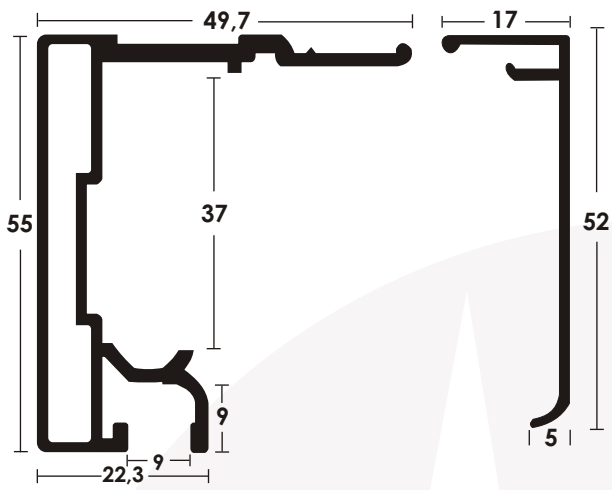

AT 104

AT 131

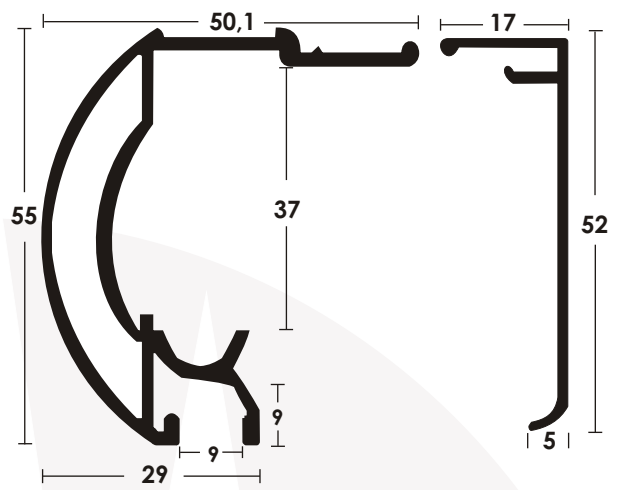

AT 132

AT 131

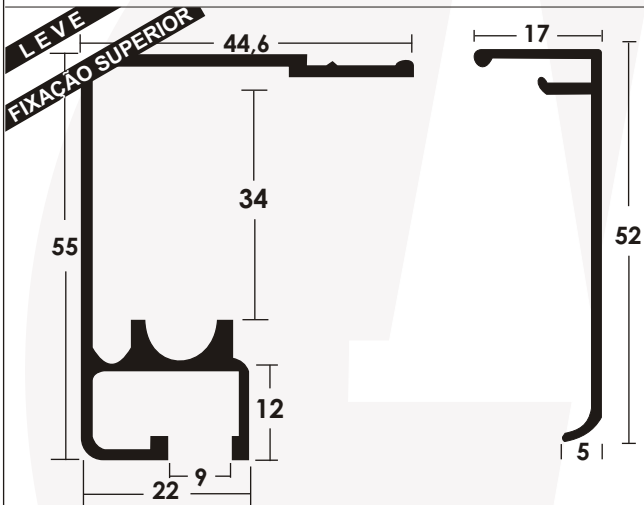

AT 105

AT 131

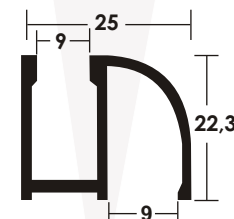

42400

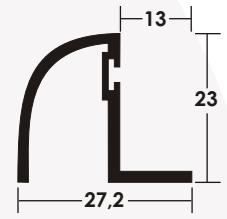

42465

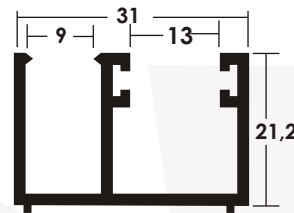

42307

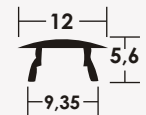

AT 130



42404

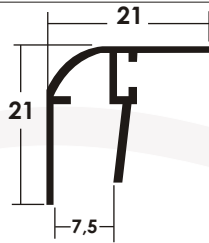

42401

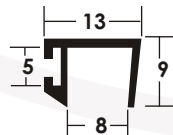

AT 15

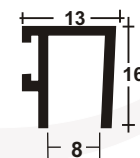

MT 15

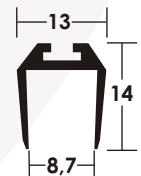

AT 220

PVC INCOLOR

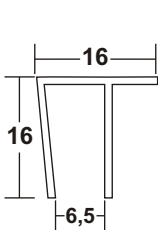

PVC401

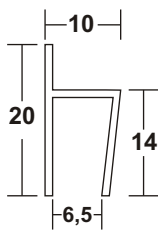

PVC404

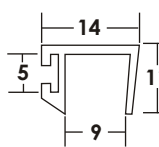

PVC 14

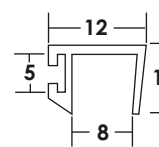

PVC 15

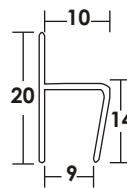

PVC 17

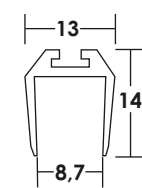

PVC 22



PVC 08

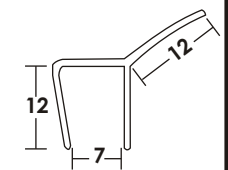

PVC RODO

8 mm

8 mm

8 mm

8 mm



www.galpaodovidraceiro.com.br

Tel: 11 2296 9000

NEXTEL: ID 55*9*48189

10 mm

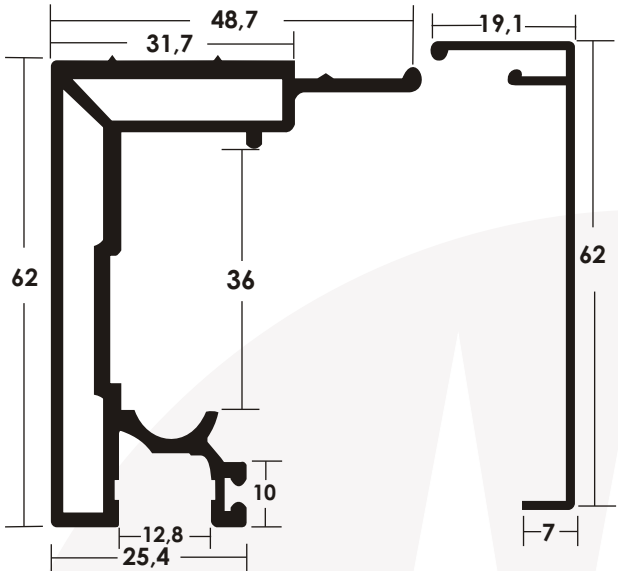

AT 01

AT 02

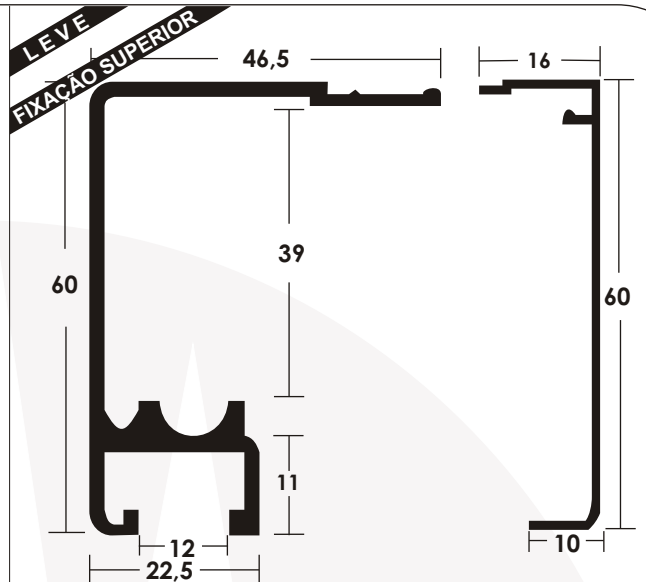

32104

42304

10 mm

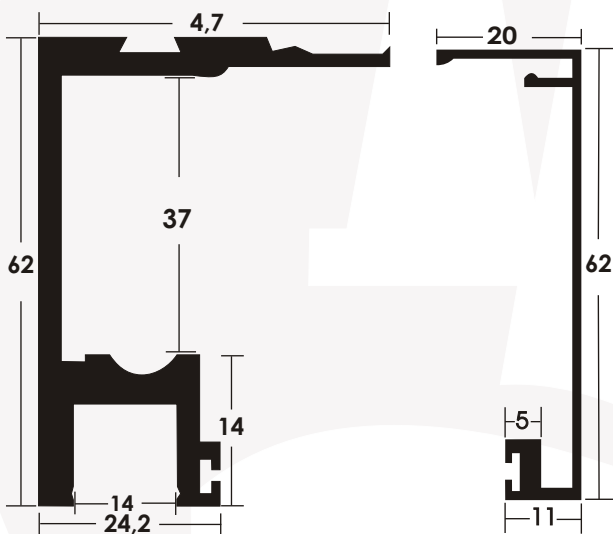

MT 1

MT 2

10 mm

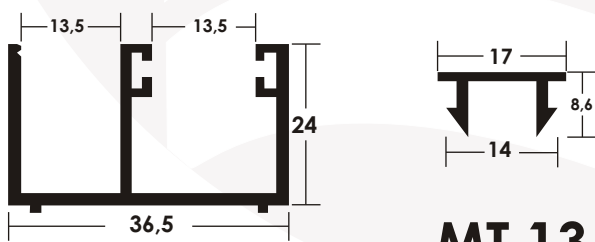

MT 5

MT 13

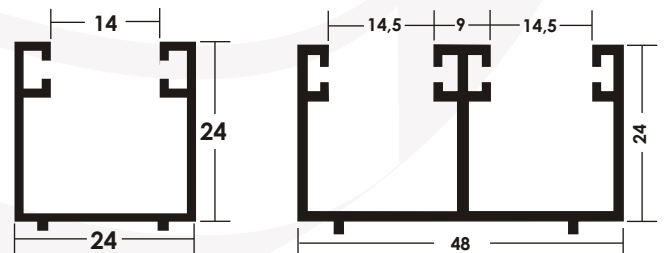

MT 6

AT 60

10 mm

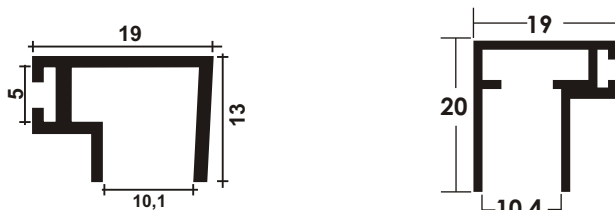

AT 14

MT 14



MT 17

AT 17



www.galpaodovidraceiro.com.br

Tel: 11 2296 9000

NEXTEL: ID 55*9*48189

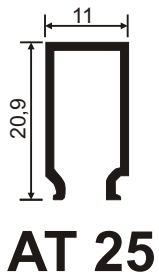

AT 25

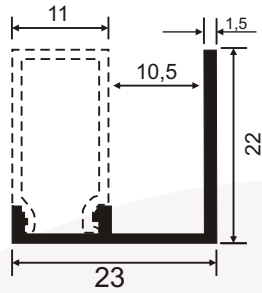

AT 24

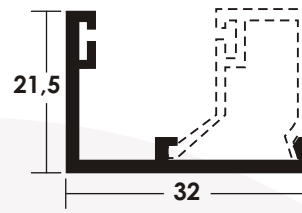

MT 26

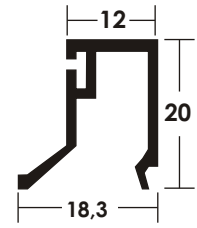

MT 27

6mm

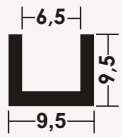

MT 28

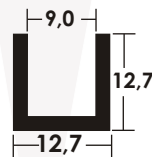

MT 30

8mm

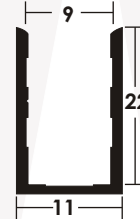

42402

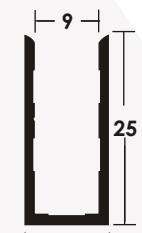

AT 405

10mm

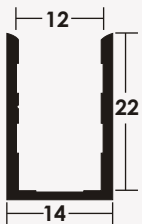

42403

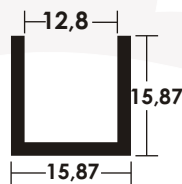

MT 12



MT 10



AT 406

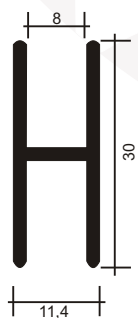

AT 16

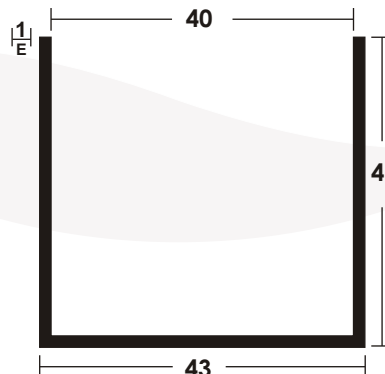

AT 43

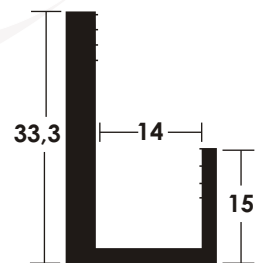

AT 80

8 mm

PERFIL "U"

PERFIL "U"

DIVERSOS



www.galpaodovidraceiro.com.br

Tel: 11 2296 9000

NEXTEL: ID 55*9*48189

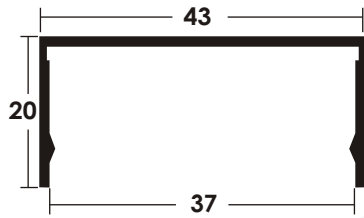

AT 134

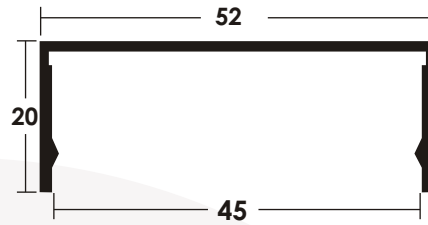

AT 340

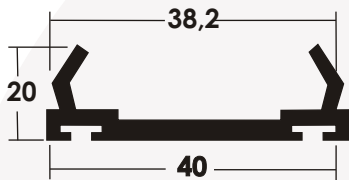

AT 135

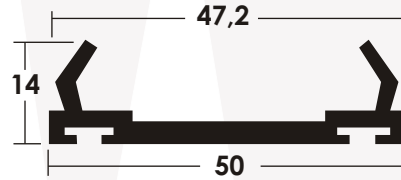

AT 350

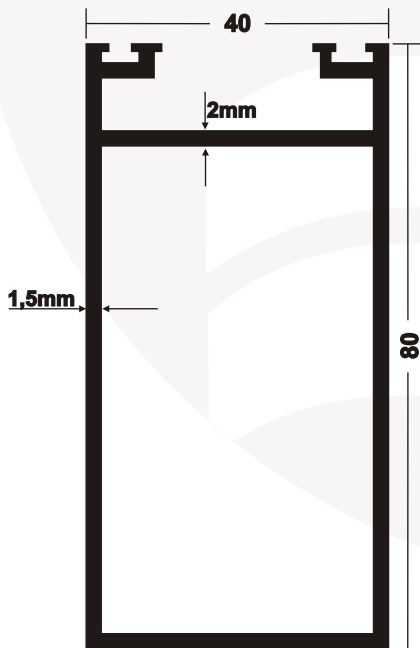

AT 136

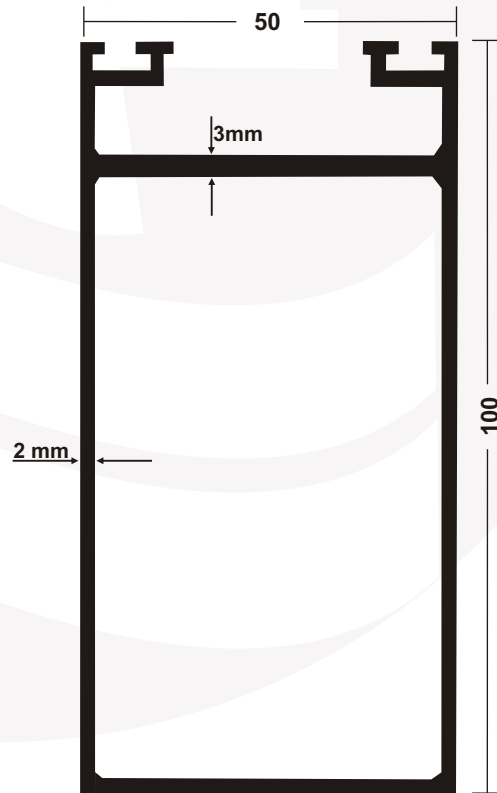

AT 360



www.galpaodovidraceiro.com.br

Tel: 11 2296 9000

NEXTEL: ID 55*9*48189

ACIMA de 1,20m
Necessita Fixação Superior

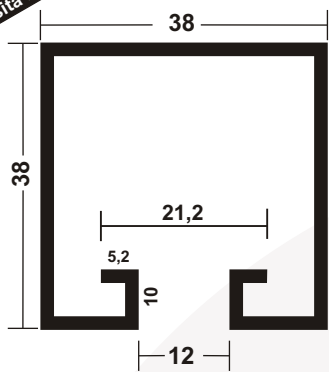

MT 37

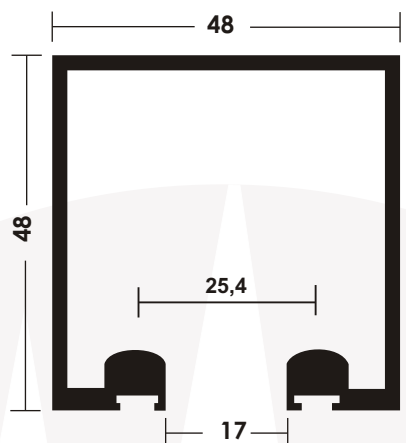

MT 68

LEVE

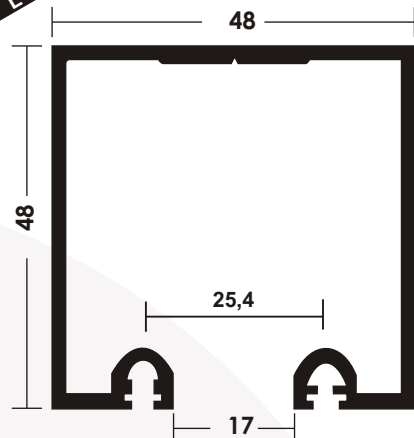

AT 69

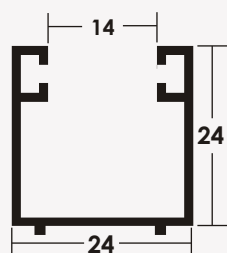

MT 6

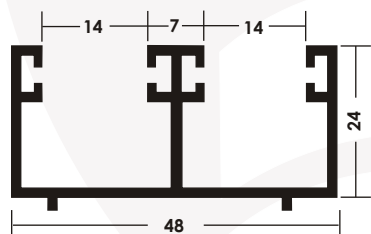

AT 60

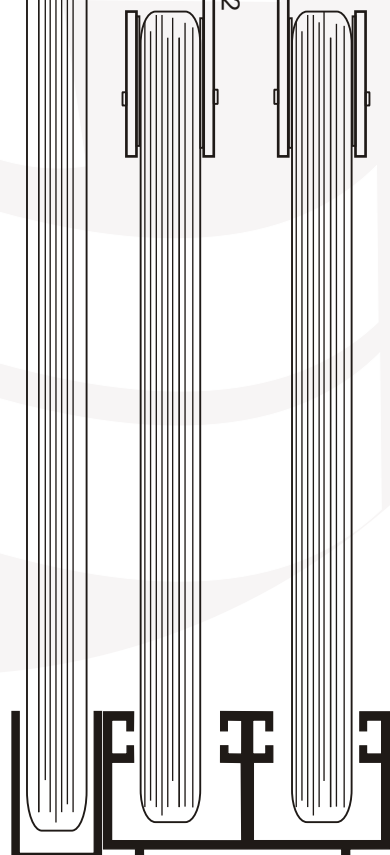
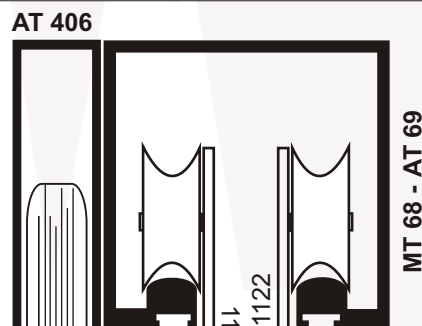

MT 10

AT 60

STANLEY



www.galpaodovidraceiro.com.br

Tel: 11 2296 9000

NEXTEL: ID 55*9*48189

DIVISÓRIA SANITÁRIA

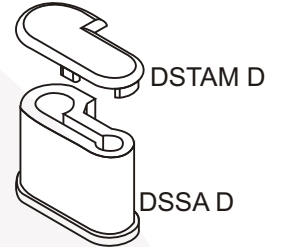
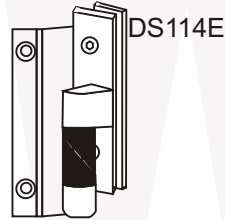
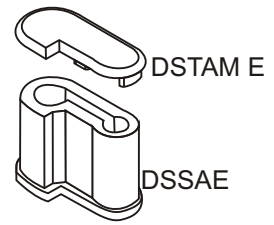
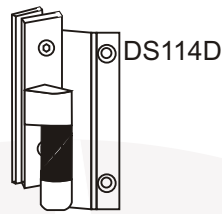
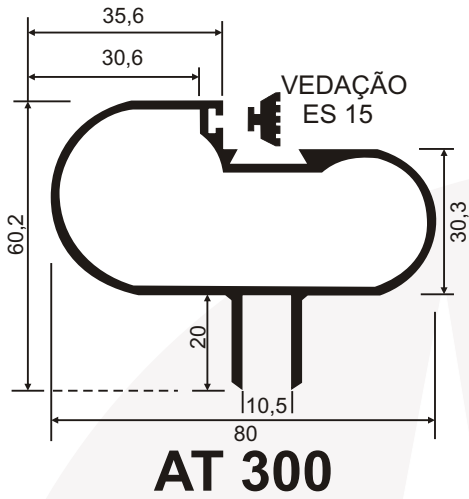

CORRIMÃO

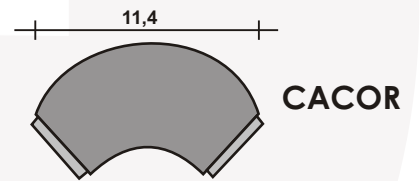
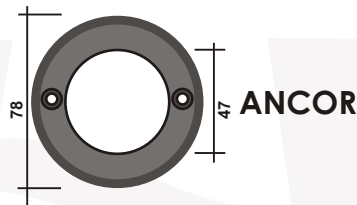
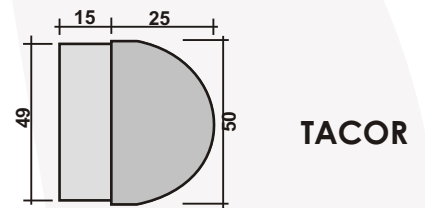
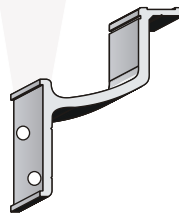
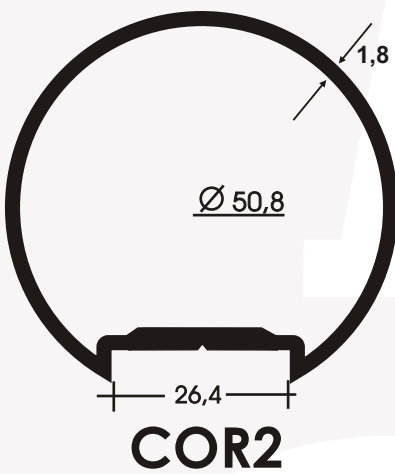

GUARDA CORPO

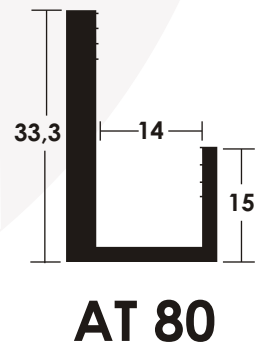
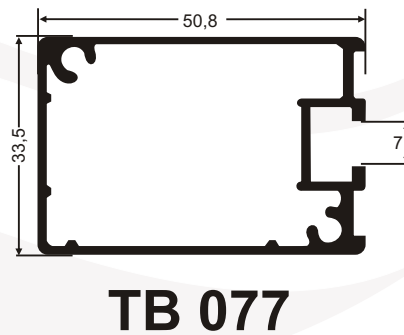
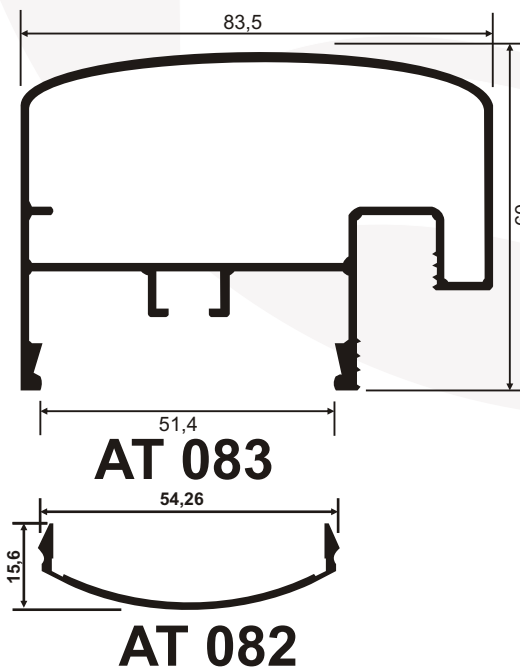

RETANGULAR



| CODIGO | H | | L | | E | |
|--------|-----|--------|-------|-------|-----|------|
| | Pol | mm | Pol | mm | Pol | mm |
| TB112 | 1/2 | 12,70 | 1 | 25,40 | - | 1,00 |
| TB212 | 2 | 50,80 | 1/2 | 12,70 | - | 1,20 |
| TB238 | 2 | 50,80 | 1 1/2 | 38,10 | - | 1,30 |
| TB2X1 | 2 | 50,80 | 1 | 25,40 | - | 2,00 |
| TB2X1L | 2 | 50,80 | 1 | 25,40 | - | 1,00 |
| TB014 | 3 | 76,20 | 1 1/2 | 38,10 | - | 1,50 |
| TB4X2 | 4 | 101,60 | 2 | 50,80 | - | 1,50 |
| TB6X2 | 6 | 152,40 | 2 | 50,80 | - | 3,00 |

QUADRADO

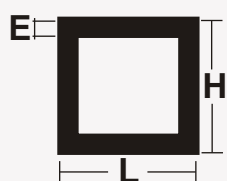

| CODIGO | H | | L | | E | |
|--------|-------|--------|-------|--------|-----|------|
| | Pol | mm | Pol | mm | Pol | mm |
| TB1X1 | 1 | 25,40 | 1 | 25,40 | - | 1,20 |
| TB 15 | 1 1/2 | 38,00 | 1 1/2 | 38,00 | - | 1,00 |
| TB2X2 | 2 | 50,80 | 2 | 50,80 | - | 1,50 |
| TB4X4 | 4 | 101,60 | 4 | 101,60 | - | 2,50 |

REDONDO

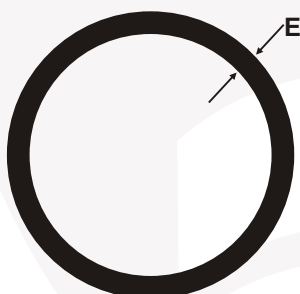

| CÓDIGO | DIAMETRO | | E | |
|--------|----------|-------|-----|------|
| | Pol | mm | Pol | mm |
| TBR1 | 1 | 25,4 | - | 1,00 |
| TBR15 | 1 1/2 | 38,00 | - | 1,60 |
| TBR2 | 2 | 50,80 | - | 1,60 |
| TBR3 | 3 | 76,20 | - | 1,60 |



PERFIL "L"

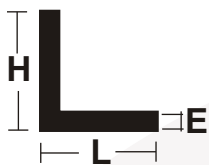

| CÓDIGO | H | | L | | E | |
|--------|-------|-------|-------|-------|------|------|
| | Pol | mm | Pol | mm | Pol | mm |
| PL1/2 | 1/2 | 12,70 | 1/2 | 12,70 | 1/16 | 1,58 |
| PL5/8 | 5/8 | 15,87 | 5/8 | 15,87 | 1/16 | 1,00 |
| PL3/4 | 3/4 | 19,00 | 3/4 | 19,00 | - | 1,00 |
| PL 1 | 1 | 25,40 | 1 | 25,40 | - | 1,00 |
| PL38 | 1 1/2 | 38,00 | 1 1/2 | 38,00 | 1/8 | 3,18 |
| PL38L | 1 1/2 | 38,00 | 1 1/2 | 38,00 | - | 1,12 |
| PL3 | 2 | 50,80 | 1 1/4 | 31,70 | - | 2,00 |
| PL4 | 2 | 50,80 | 2,0 | 50,80 | 1/8 | 3,18 |

PERFIL "T"

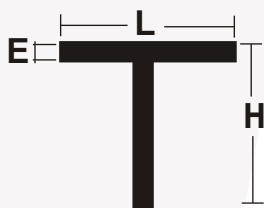

| CÓDIGO | H | | L | | E | |
|--------|-----|-------|-----|-------|-----|------|
| | Pol | mm | Pol | mm | Pol | mm |
| AT70 | 1 | 25,40 | 1 | 25,40 | - | 2,00 |

BARRA CHATA



| CÓDIGO | L | | E | |
|--------|-------|-------|-----|------|
| | Pol | mm | Pol | mm |
| AT 72 | 5/8 | 15,87 | 1/8 | 3,18 |
| AT 73 | 1 | 25,40 | 1/8 | 3,18 |
| AT 74 | 1 1/2 | 38,00 | 1/8 | 3,18 |
| AT 75 | 2 | 50,80 | 1/8 | 3,18 |





Galpão do Vidraceiro[®]

ENVIDRAÇAMENTO

DE SACADA

**Tel: 11 2614 7350
11 2296 9000**

ID: 55*9*48189

www.galpaodovidraceiro.com.br

Rua Candido Vale, 332 Tatuapé-São Paulo - SP

CATÁLOGO DE ALUMÍNIO

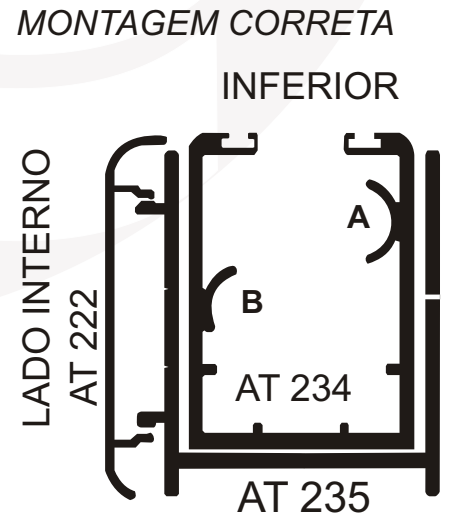
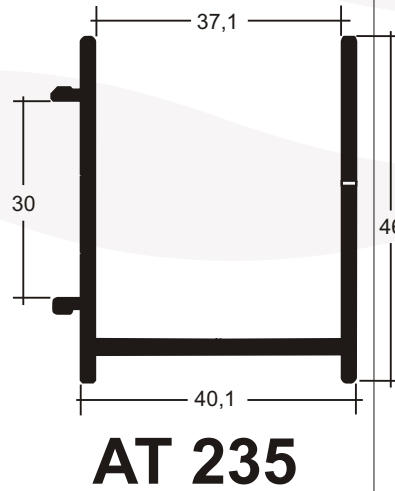
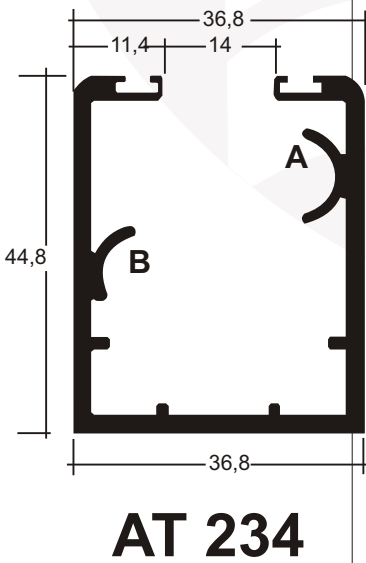
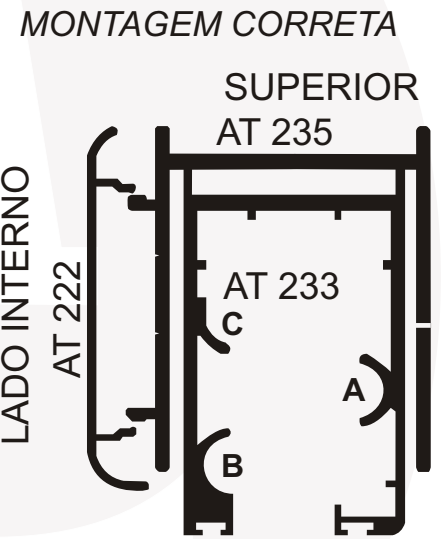
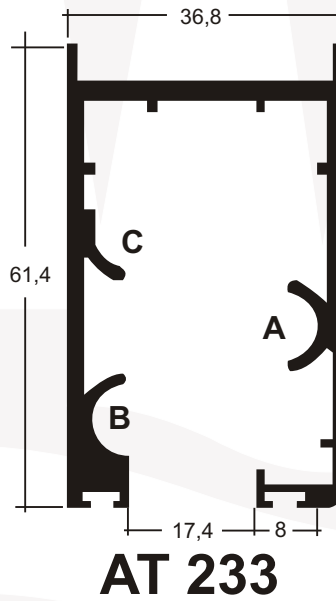
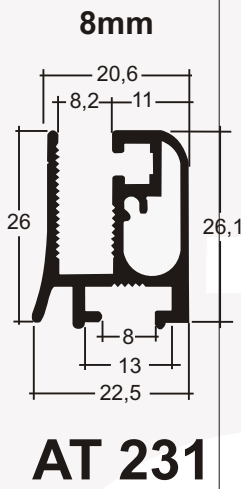
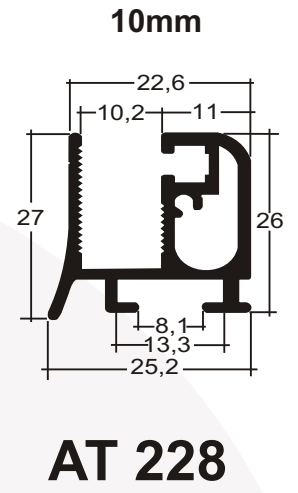
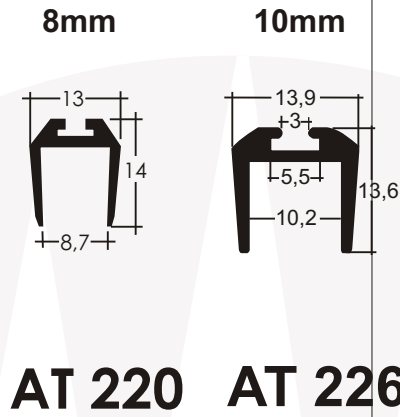
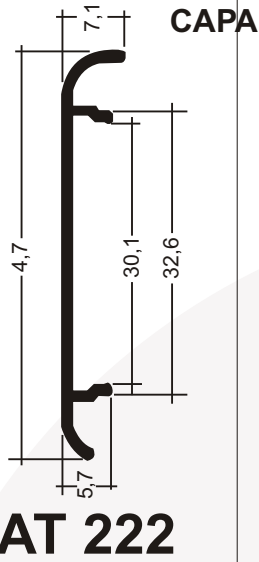

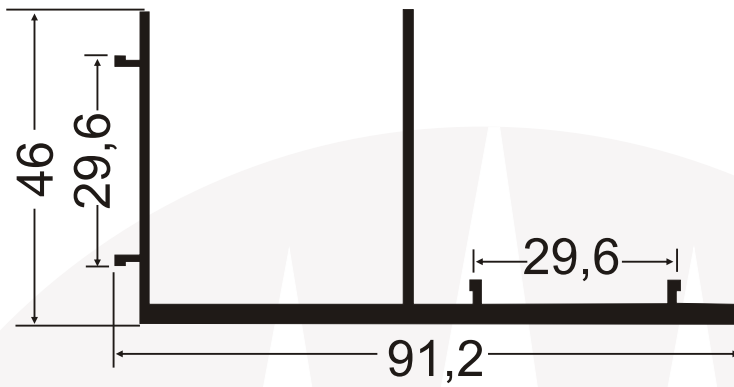
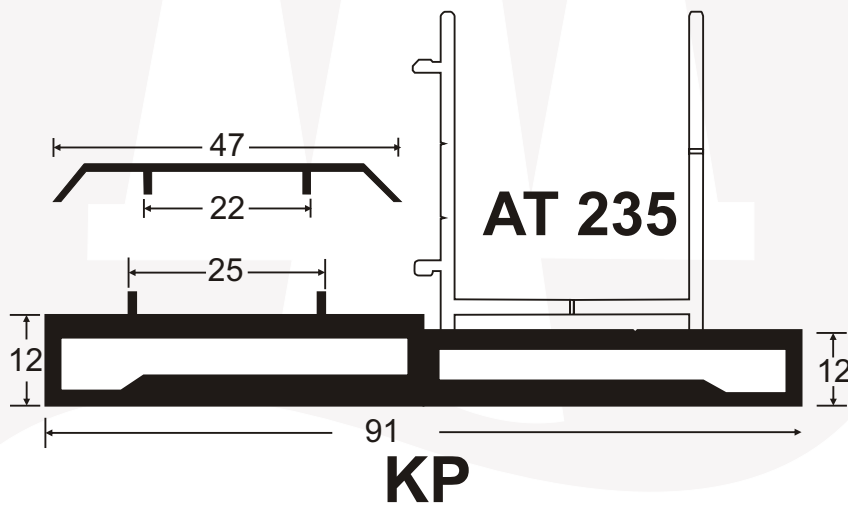
**AT 237****KIT PROLONGADOR (CHAPA+CAPA)****AT 235****KP**

www.galpaodovidraceiro.com.br

Tel: 11 2296 9000

NEXTEL: ID 55*9*48189

ROLAMENTOS

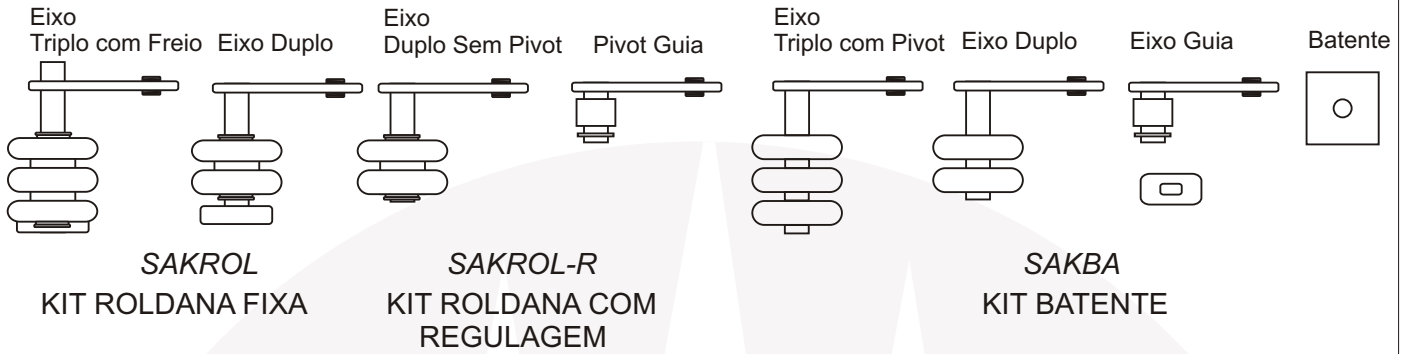

Haste - 300mm- Alumínio



Haste - 300mm - Nylon



SAHY DUPLO

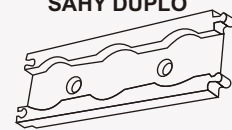

GUIAS DE AJUSTE

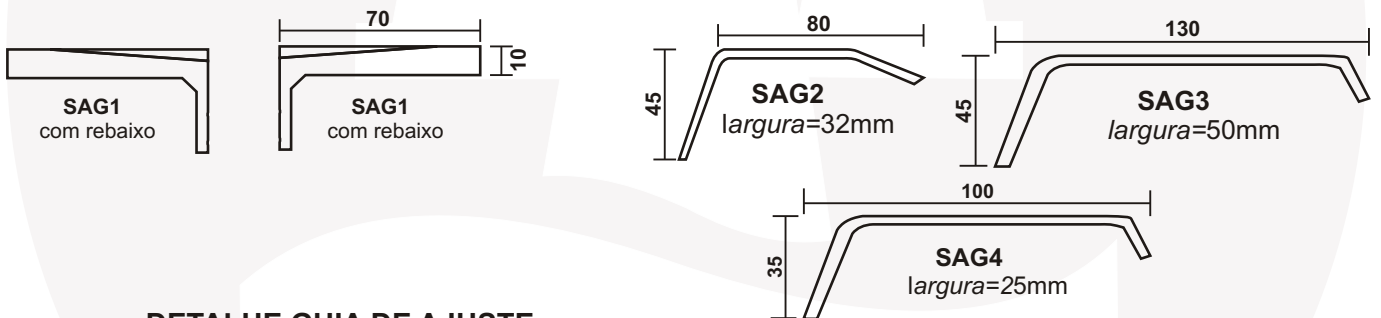

DETALHE GUIA DE AJUSTE

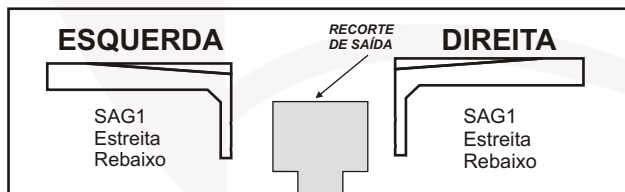

AT 233
TRILHO SUPERIOR

FIXADORES

Chumbadores



NYLON

CBN 1/4x3"
CBN 1/4x2"
CBN 5/16x2 1/4
CBN 3/8x2 1/2

AÇO

CBA 1/4x1 1/4"
CBA 3/8x4.5/16"
CBA 3/8x3 1/8"
CBA 5/16x2.3/16"

Parafusos/ Buchas

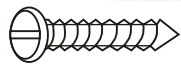

PA-A4,2x32
PA-A 3,5x22
PA-A 4,2x9,5 Inox

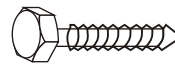

PARRS

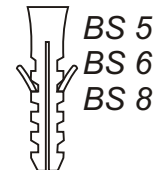

BS 5
BS 6
BS 8



POP 310
POP 410
POP 510

Alumínio/Aço



www.galpaovidraceiro.com.br

Tel: 11 2296 9000

NEXTEL: ID 55*9*48189

VEDAÇÃO

Borrachhas

 ES23

 ES26

 ES16

 ES25

Escovas de Polipropileno



1040 - 5x8mm

1041 - 5x10mm

1045 - 5x5mm - Auto Adesiva

1046 - 5x7mm - Auto Adesiva

1047 - 7x7mm - Auto Adesiva

COLAS

Poliuretano Persilox



SIKAFLEX 256



SILPE

Aplicador



APLICA6

ACABAMENTOS

Arremate Leito Dir/Esq



SAARL

Arremate de Saída



Furo
p/ Rebite 3mm



Furo
p/ Rebite 3mm

SAARS

FECHADURA PUXADOR

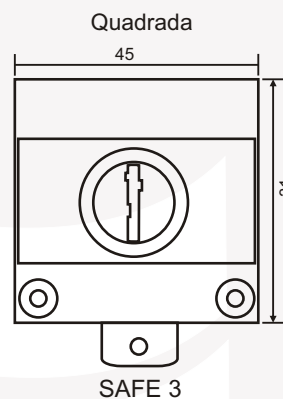
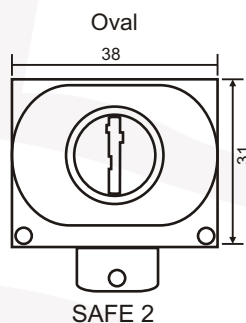
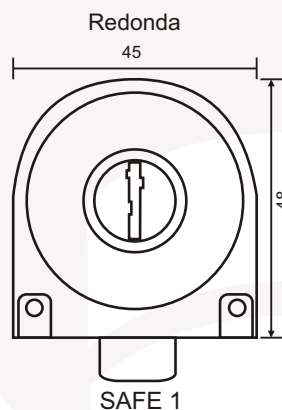

Caixa de Saída c/ Guia de Ajuste

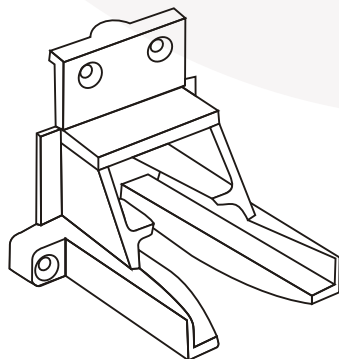

Aparador

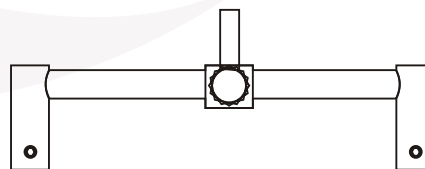

SAAP 15/65CM



www.galpaodovidraceiro.com.br

Tel: 11 2296 9000

NEXTEL: ID 55*9*48189

SACADA

SACADA

SACADA



www.galpaodovidraceiro.com.br

Tel: 11 2296 9000

NEXTEL: ID 55*9*48189



Galpão do Vidraceiro®



CARRINHOSxTRILHOS

Tel: 11 2614 7350
11 2296 9000
ID: 55*9*48189

www.galpaodovidraceiro.com.br

Rua Candido Vale, 332 Tatuapé-São Paulo - SP

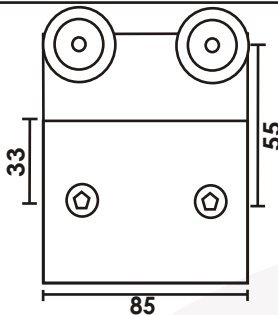
CATÁLOGO DE ALUMÍNIO

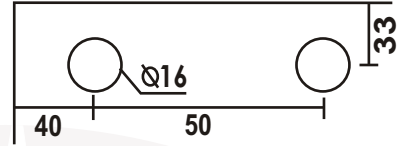
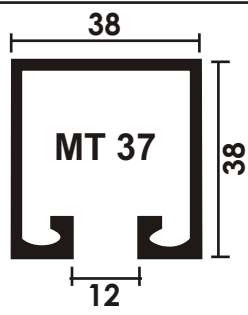
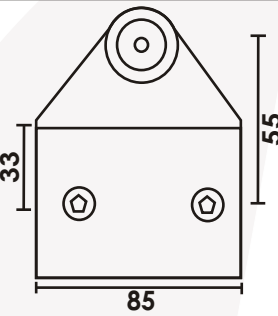
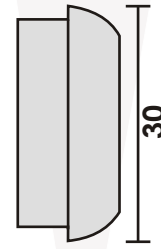
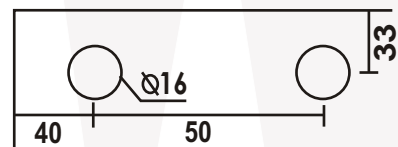
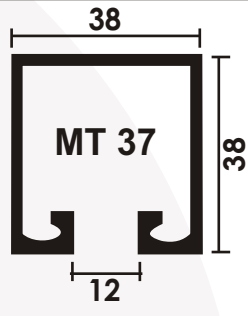
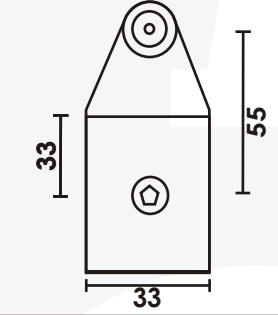
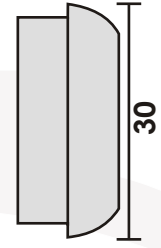
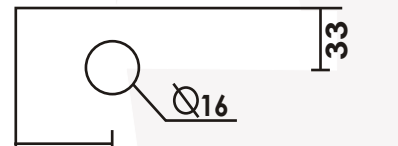
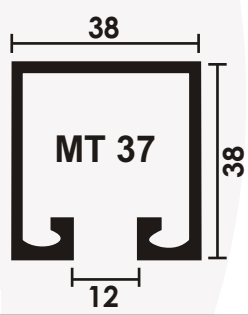
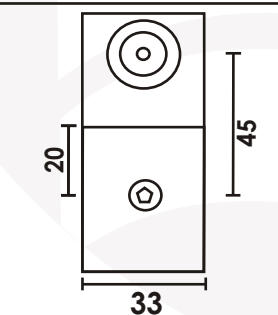
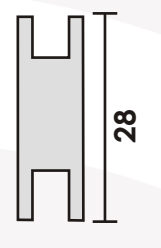
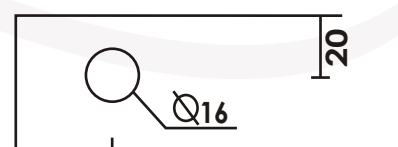
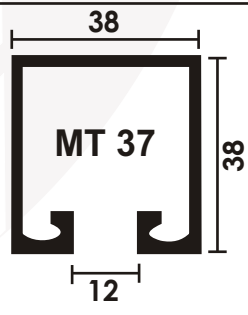
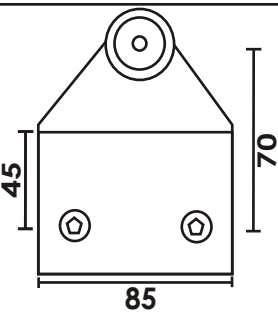
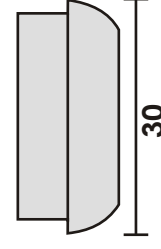
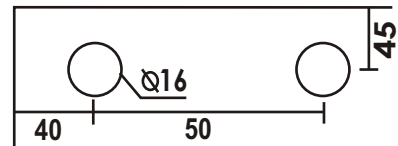
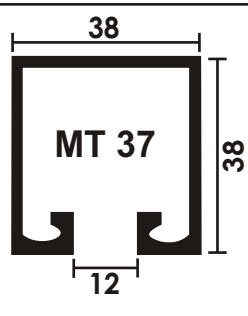
| CÓDIGO | MODELO | RODÍZIO | RECORTE | ALUMÍNIO |
|--------|---|--|--|---|
| 1126 |  | MEIA CANA  |  |  |
| 1126A |  | MEIA CANA  |  |  |
| 1126B |  | MEIA CANA  |  |  |
| 1126T |  | CANALETA  |  |  |
| 2520 |  | MEIA CANA  |  |  |

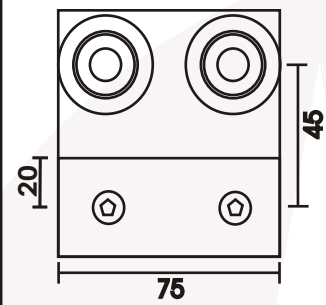
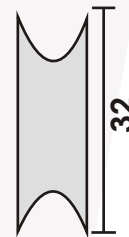
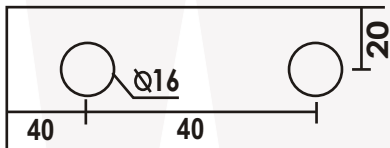
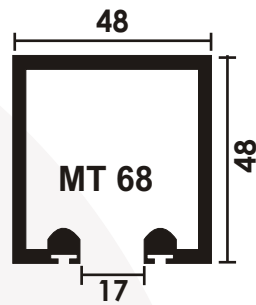
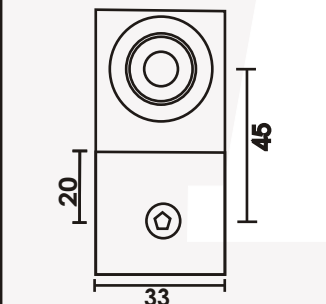
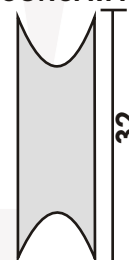
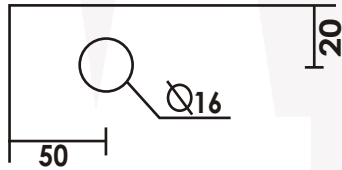
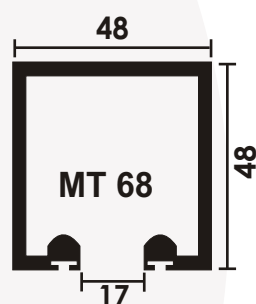
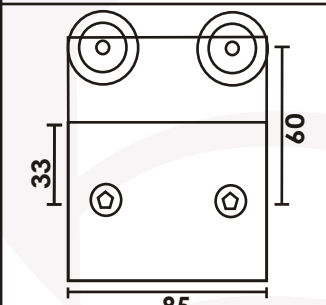
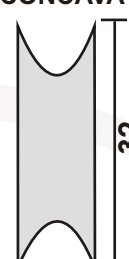
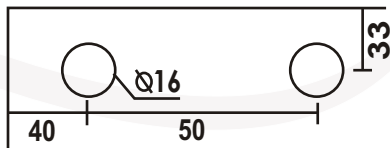
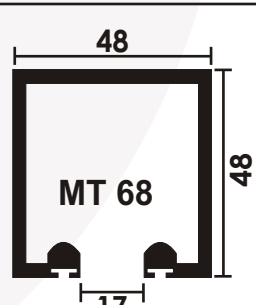
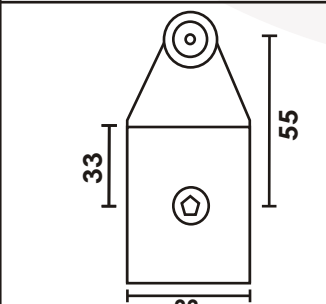
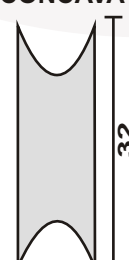
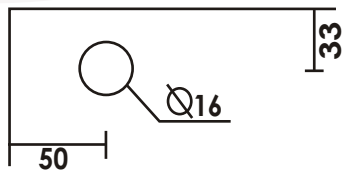
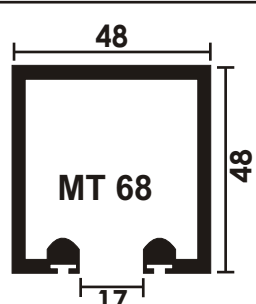
| CÓDIGO | MODELO | RODÍZIO | RECORTE | ALUMÍNIO |
|--------|---|--|--|---|
| 1122 |  | CÔNCAVA  |  |  |
| 1122B |  | CÔNCAVA  |  |  |
| 1126DC |  | CÔNCAVA  |  |  |
| 1126MC |  | CÔNCAVA  |  |  |



www.galpaodovidraceiro.com.br

Tel: 11 2296 9000

NEXTEL: ID 55*9*48189

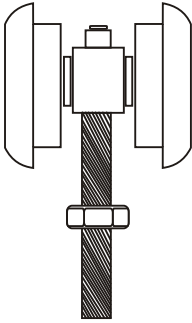
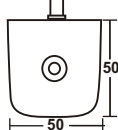
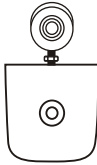
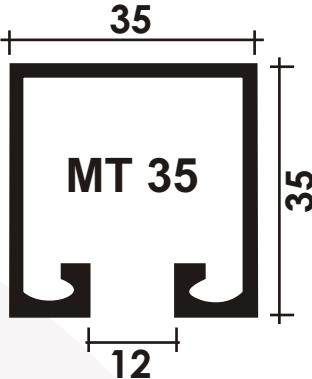
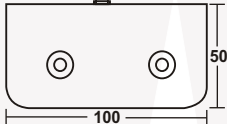
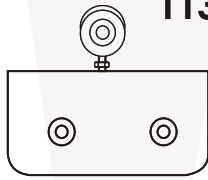
| RODÍZIO | FERRAGEM | COMPOSIÇÃO | ALUMÍNIO |
|--|--|---|---|
|  RO-D35 | 1123  | 1123S-35  |  MT 35 |
| | 1130  | 1130S-35  | |

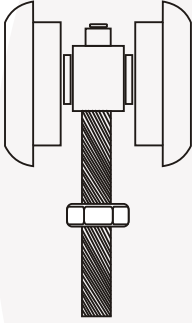
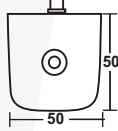
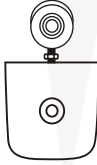
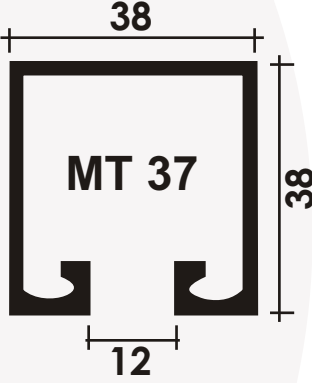
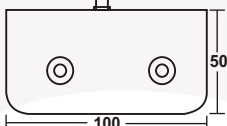
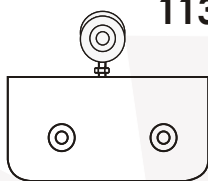
| RODÍZIO | FERRAGEM | COMPOSIÇÃO | ALUMÍNIO |
|---|--|---|--|
| DUPLO  RO-D37 | 1123  | 1123S-37  |  MT 37 |
| | 1130  | 1130S-37  | |

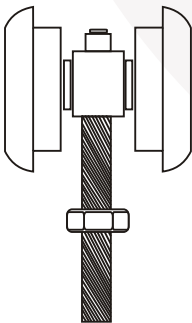
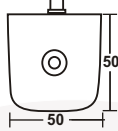
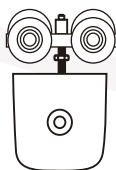
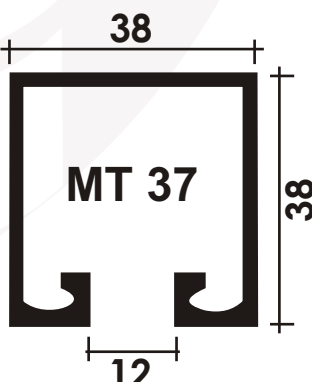
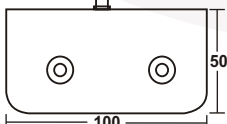
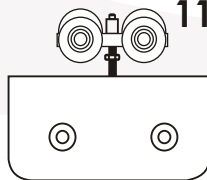
| RODÍZIO | FERRAGEM | COMPOSIÇÃO | ALUMÍNIO |
|--|--|--|---|
| QUADRUPLO  RO-Q37 | 1123  | 1123SD-37  |  MT 37 |
| | 1130  | 1130SD-37  | |



www.galpaodovidraceiro.com.br

Tel: 11 2296 9000

NEXTEL: ID 55*9*48189

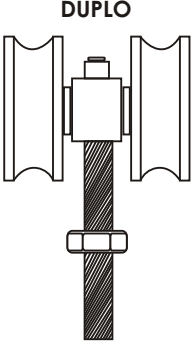
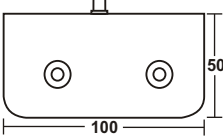
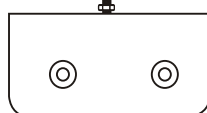
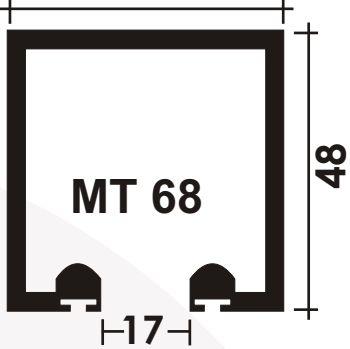
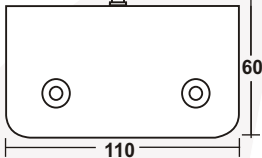
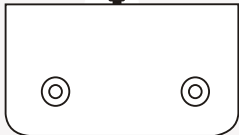
| RODÍZIO | FERRAGEM | COMPOSIÇÃO | ALUMÍNIO |
|---|--|---|--|
| <p>DUPLO</p>  <p>RO-D68</p> | <p>1130</p>  | <p>1130C-68</p>  | <p>48</p>  <p>MT 68</p> <p>48</p> <p>17</p> |
| | <p>1127A</p>  | <p>1127C-68</p>  | |

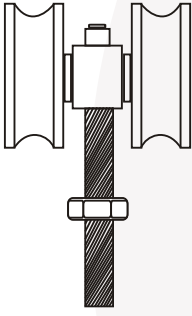
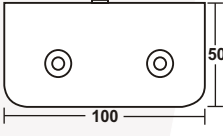
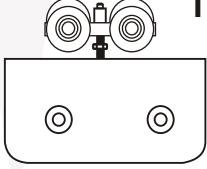
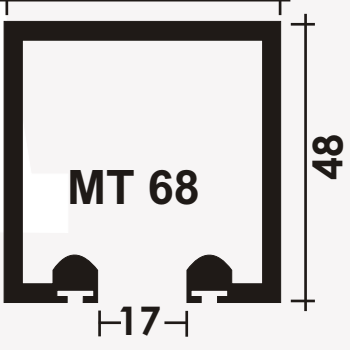
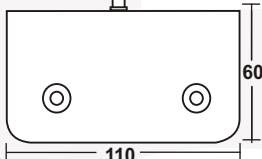
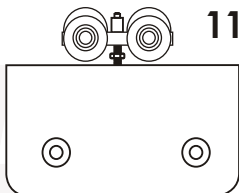
| RODÍZIO | FERRAGEM | COMPOSIÇÃO | ALUMÍNIO |
|--|--|--|---|
| <p>QUADRUPLO</p>  <p>RO-Q68</p> | <p>1130</p>  | <p>1130CD-68</p>  | <p>48</p>  <p>MT 68</p> <p>48</p> <p>17</p> |
| | <p>1127A</p>  | <p>1127CD-68</p>  | |





www.galpaodovidraceiro.com.br

Tel: 11 2296 9000

NEXTEL: ID 55*9*48189



www.galpaodovidraceiro.com.br

Tel: 11 2296 9000

NEXTEL: ID 55*9*48189

Tudo a pronta entrega



Curta-nos no facebook

<https://www.facebook.com/pages/Galpao-do-Vidraceiro/351300888315230>



www.galpaodovidraceiro.com.br

Tel: 11 2296 9000

NEXTEL: ID 55*9*48189